

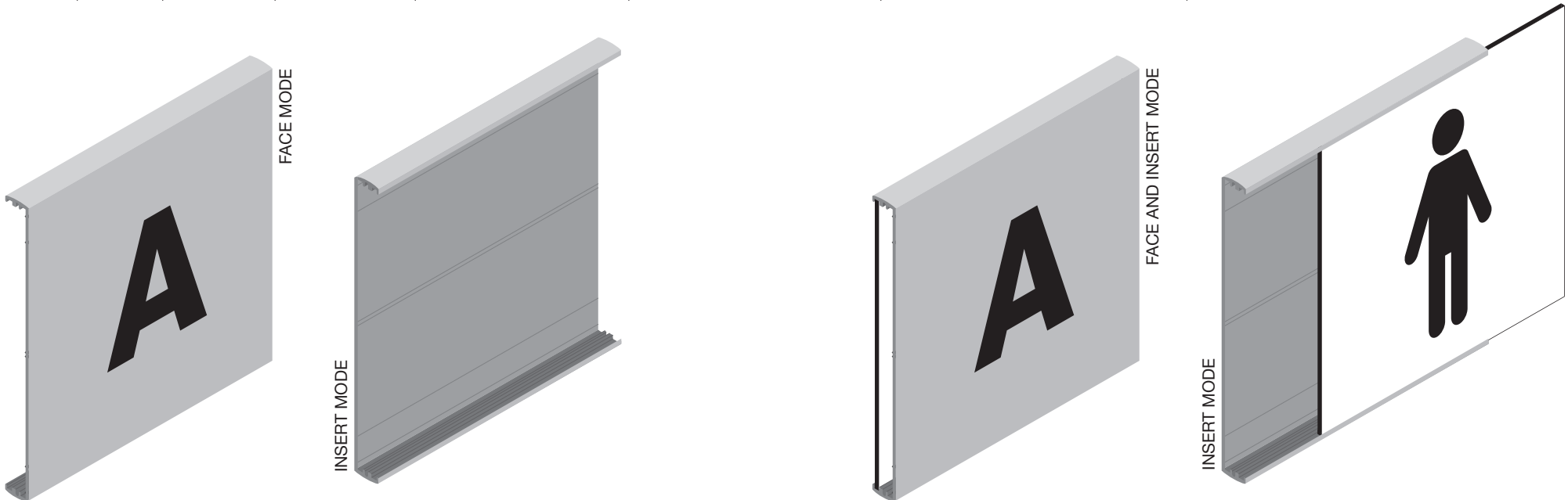

July 2017

Aluminium

	150mm	225–250mm	300mm	500mm	600mm	750mm	1000mm
25mm							
50mm							
75mm							
100mm							
150mm							



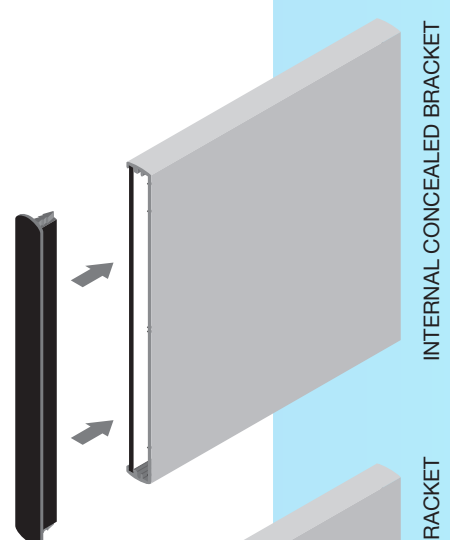
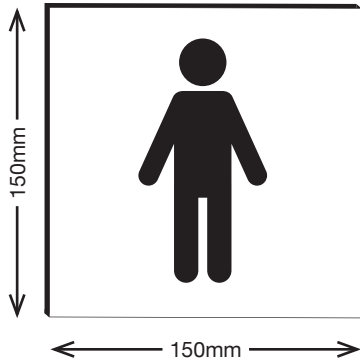

INTERNAL CONCEALED BRACKET

INTERNAL CONCEALED BRACKET

CONFIGURATIONS

- Available in all Panel Sizes 25mm to 150mm
- Combined FACE and INSERT Mode, Single or Double Sided (shown)
- Double Sided FACE Mode
- Double Sided INSERT Mode

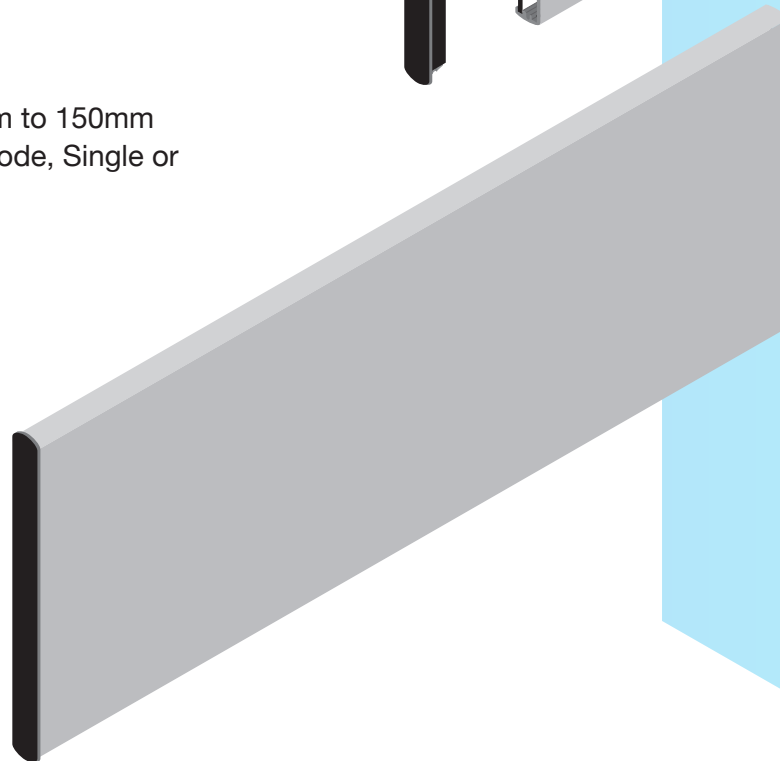

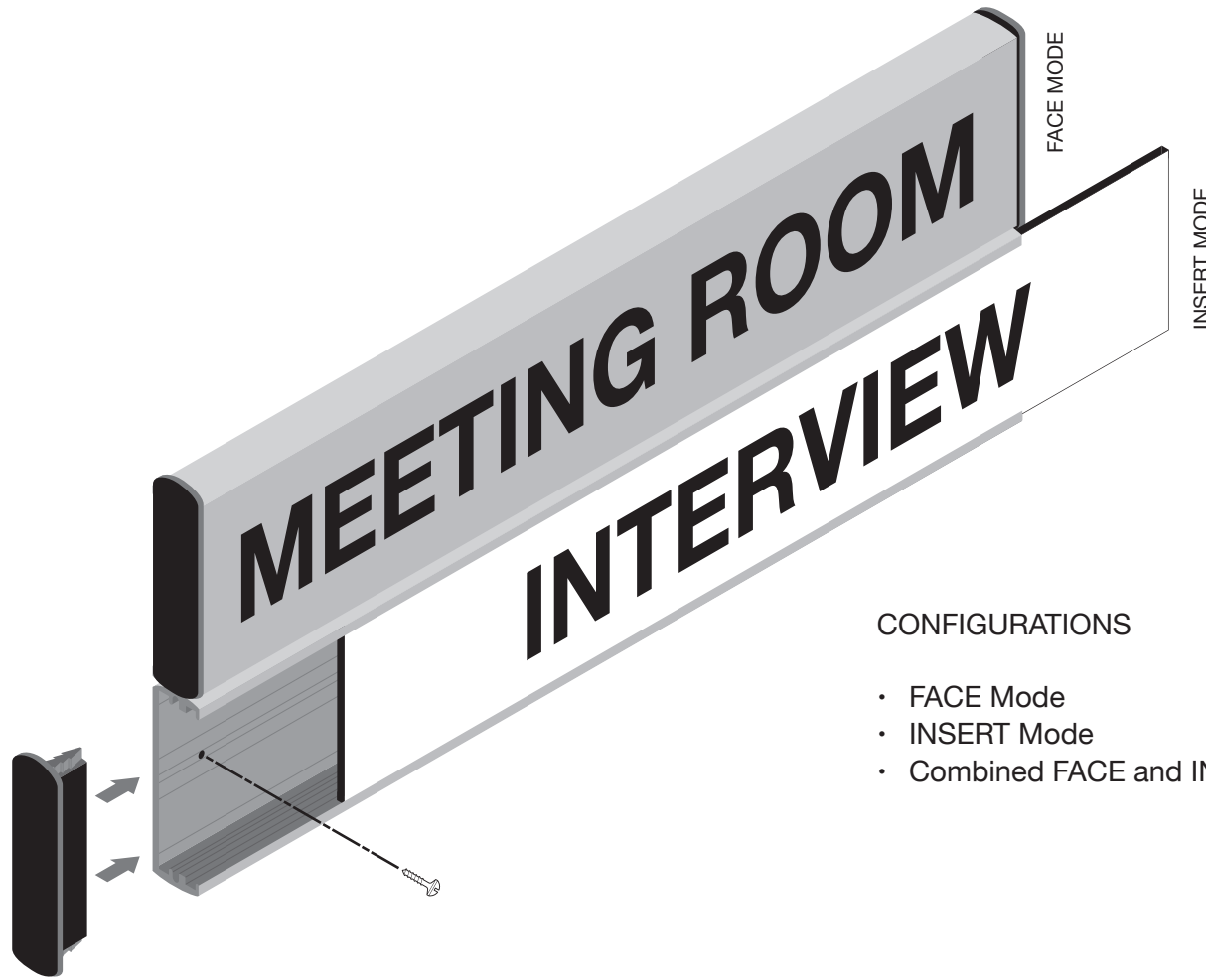

CONFIGURATIONS

- FACE Mode
- INSERT Mode
- Combined FACE and INSERT Mode (shown)

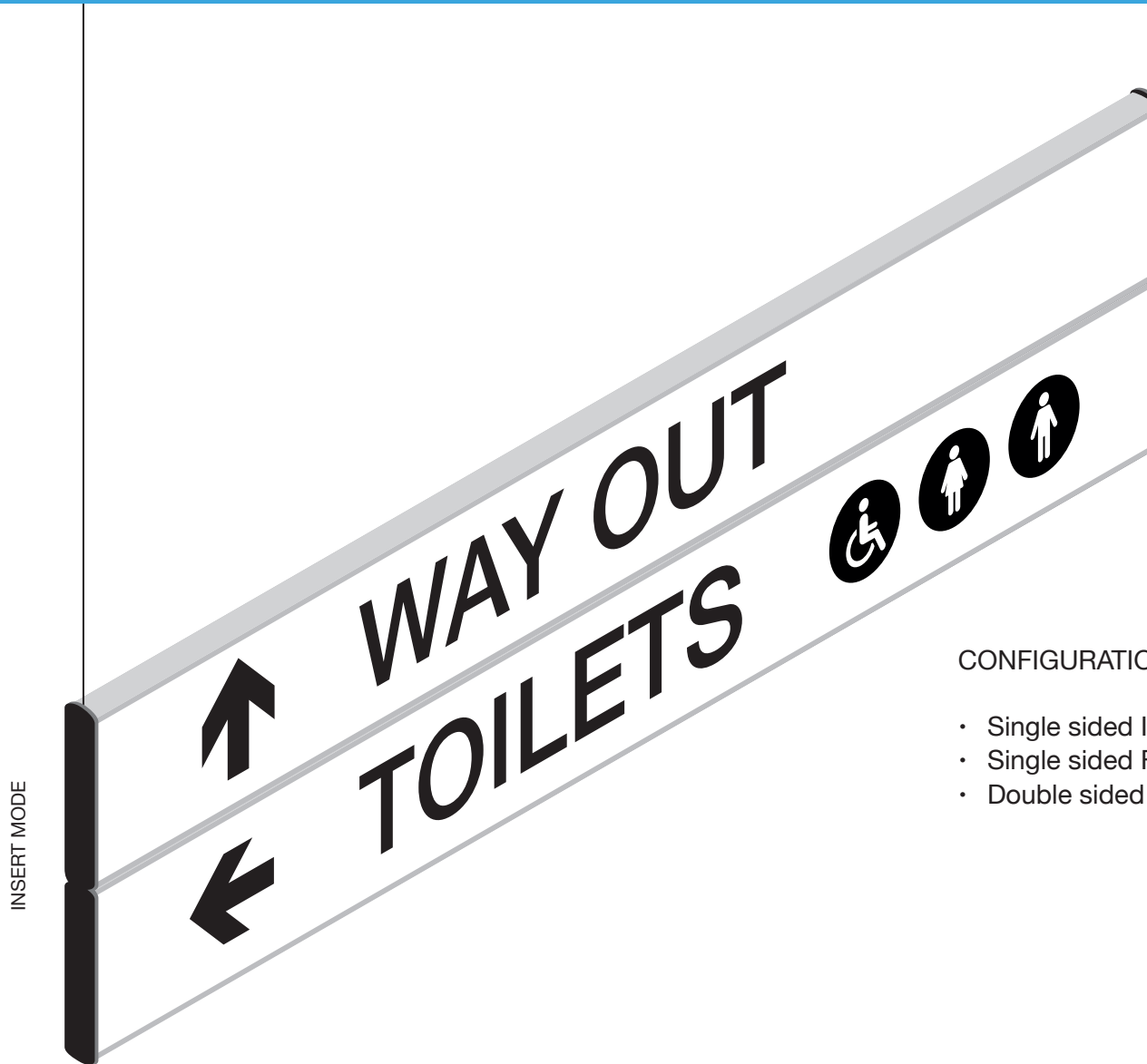

CONFIGURATIONS

- Single sided INSERT Mode (shown)
- Single sided FACE Mode
- Double sided combined INSERT and FACE Mode

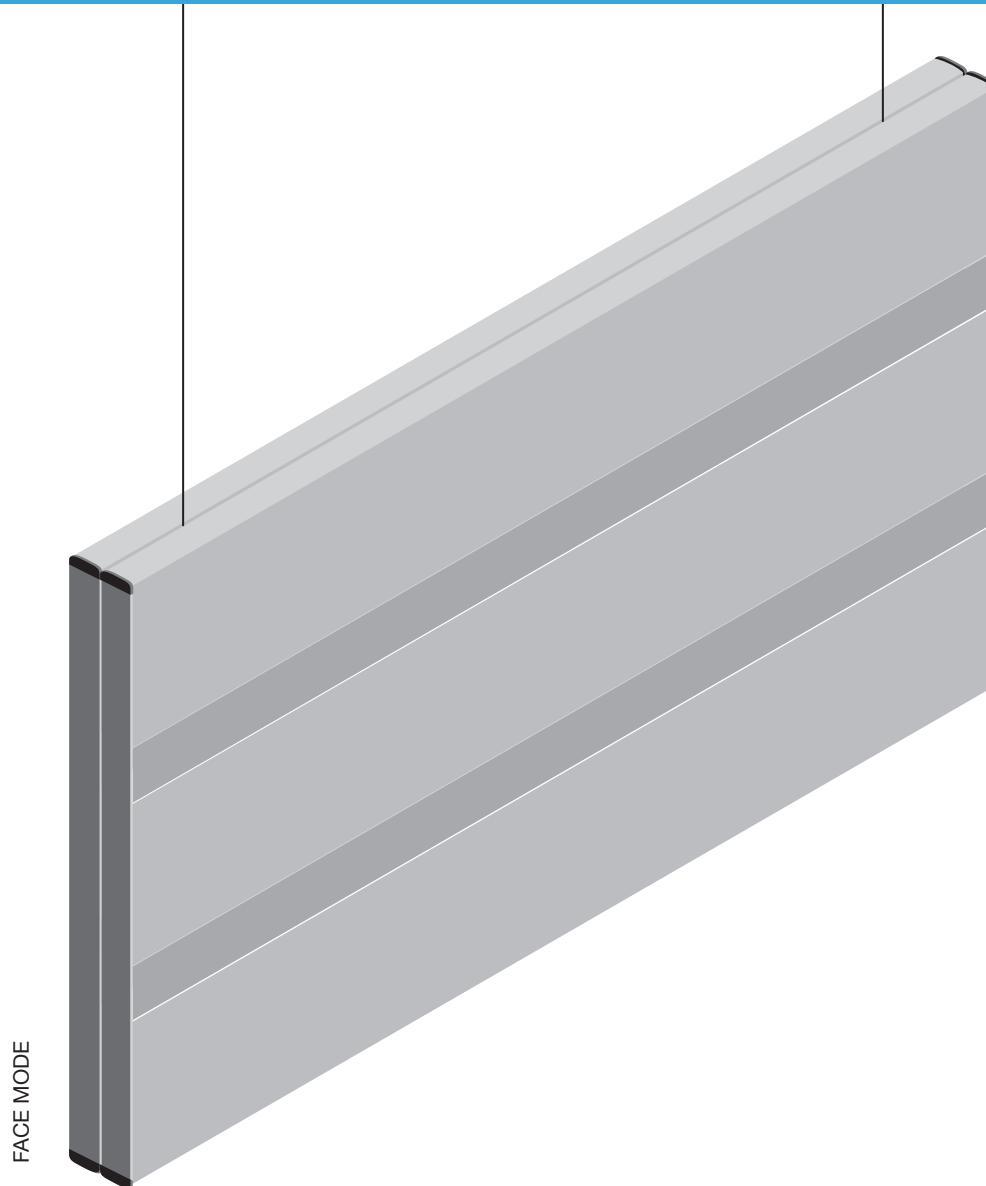

CONFIGURATIONS

- Double sided FACE Mode (shown)
- Double sided INSERT Mode

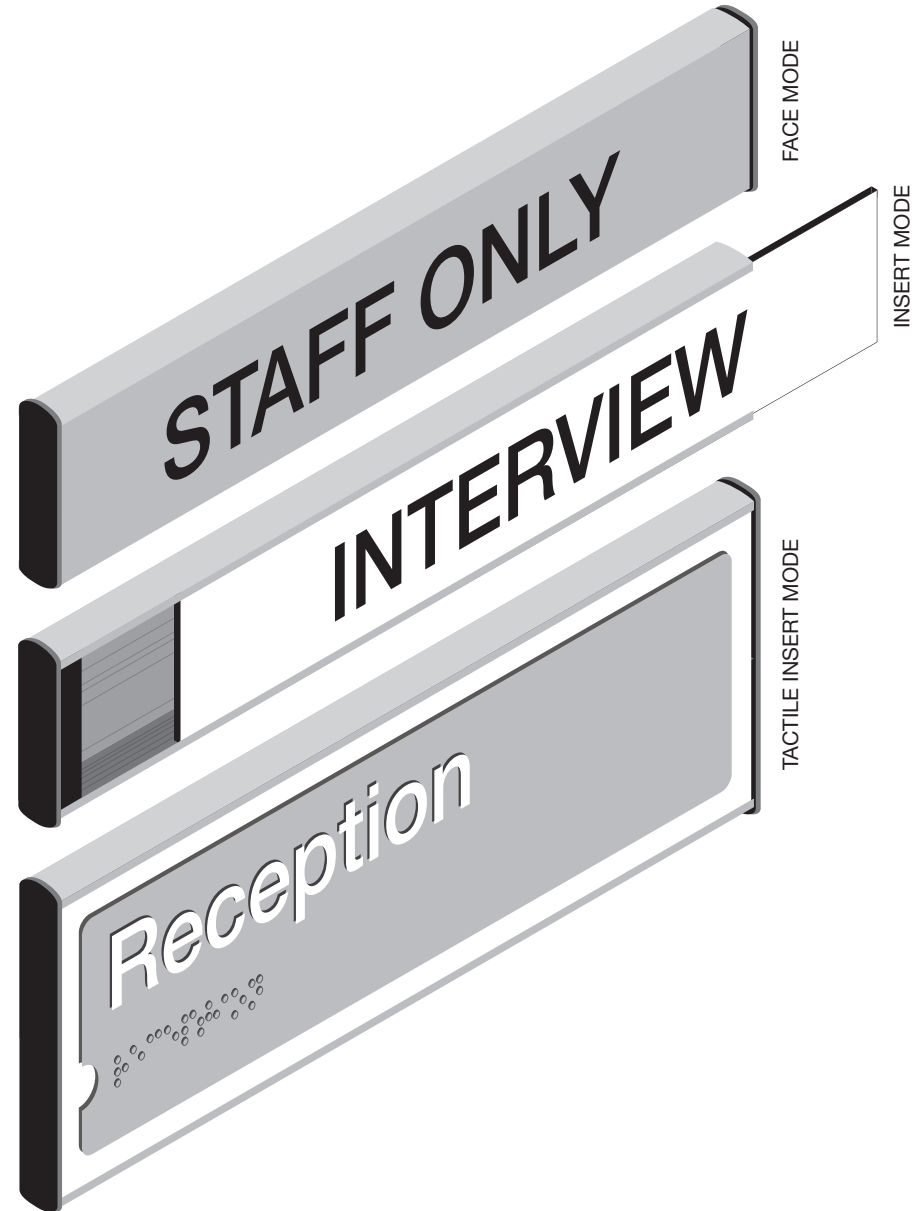
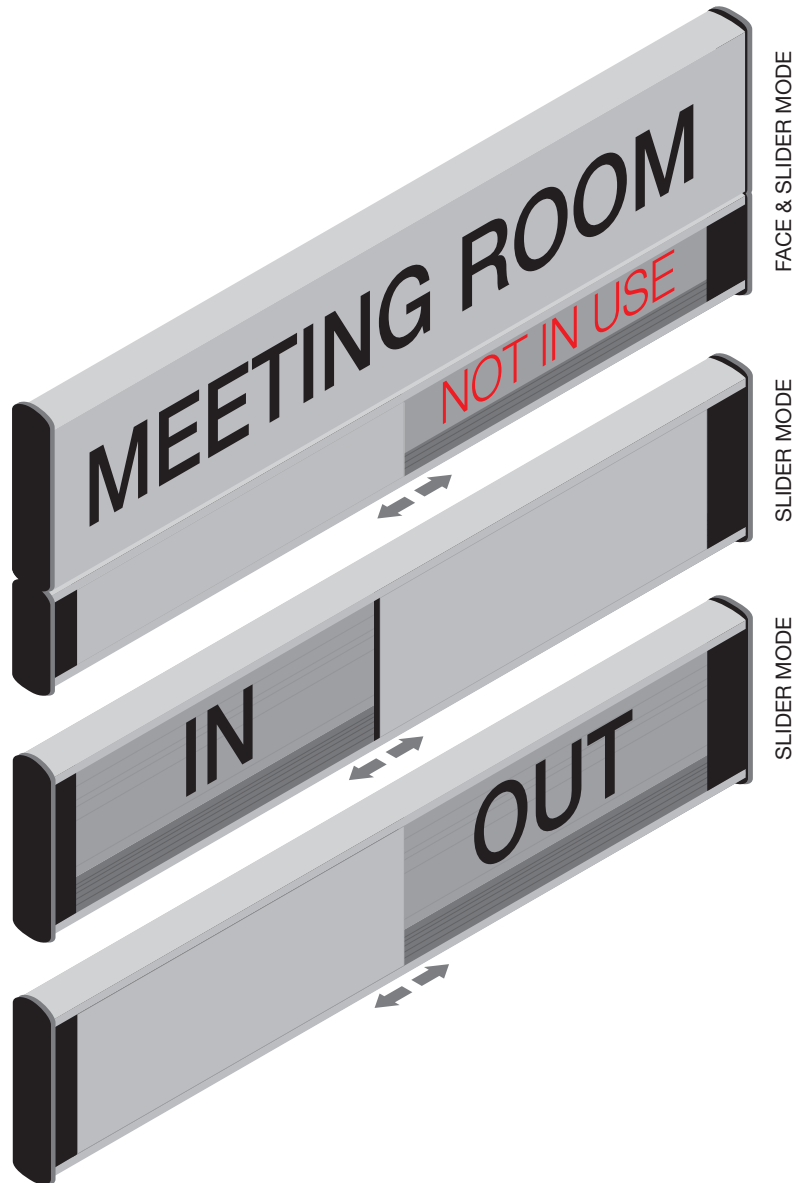

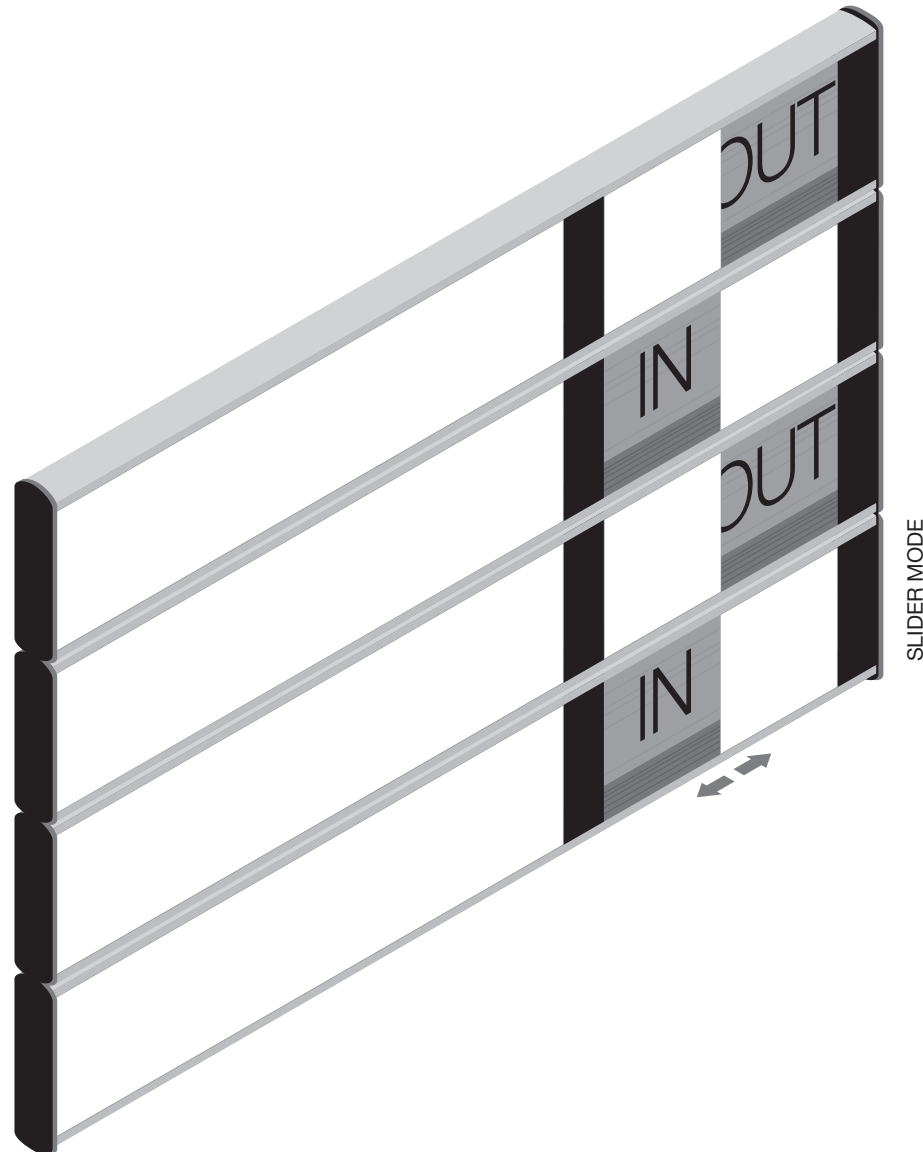

CONFIGURATIONS

- INSERT Mode Only (shown)

CONFIGURATIONS

- FACE Mode (shown)
- INSERT Mode
- Combined FACE and INSERT Mode

